



INSTALLATION, OPERATION AND MAINTENANCE MANUAL

Warning

Please read carefully before proceeding with installation. Your failure to follow any attached instructions or operating parameters may lead to the product's failure.

Save manual for future reference

Model: RO-PURE



System Tested and certified by NSF International & WQA against NSF/ANSI Standard 58 for the reduction of the claims specified on the performance data sheet.



Refer to enclosed warranty for operating parameters to ensure proper use with your water supply.

Watts Premier, Inc.
Phone: 800-752-5582

1725 W. Williams Drive C-20
www.wattspremier.com

Phoenix, AZ 85027
Fax: 623-931-0191

Thank you for your purchase of a state of the art Watts Premier Reverse Osmosis (RO) water treatment system. Water quality concerns are becoming more of a focus for the public. You may have heard about contaminants in the drinking water such as Arsenic, Perchlorate, Chromium, Cryptosporidium or Giardia. There may also be some local water issues such as high levels of Lead and Copper. This Watts Premier water treatment system has been designed and tested to provide you with high quality drinking water for years to come. The following is a brief overview of the system.

Your Reverse Osmosis System:

Osmosis is the process of water passing through a semi permeable membrane in order to balance the concentration of contaminants on each side of the membrane. A semi permeable membrane is a barrier that will pass only certain particles like clean drinking water, but not other particles like arsenic and lead.

Reverse osmosis uses a semi permeable membrane; however, by applying pressure across the membrane, it concentrates contaminants (like a strainer) on one side of the membrane, producing crystal clear water on the other. This is why RO systems produce both clean drinking water and rinse water that is flushed from the system. This reverse osmosis system also utilizes carbon block filtration technology, and can therefore provide a higher quality drinking water than carbon filtration systems alone.

Your system is a four stage RO which is based upon separate treatment segments within the one complete water filtration system. These stages are as follows:

Stage 1 – Sediment filter, recommended change 6 months.

The first stage of your RO system is a five micron sediment filter that traps sediment and other particulate matter like dirt, silt and rust which affect the taste and appearance of your water.

Stage 2 – Carbon filter, recommended change 6 months.

The second stage contains a 5 micron carbon block filter. This helps ensure that chlorine and other materials that cause bad taste and odor are greatly reduced.

Stage 3- Membrane, recommended change 2-5 years.

Stage three is the heart of the reverse osmosis system, the RO membrane. This semi permeable membrane will effectively remove TDS, Sodium and a wide range of contaminants such as Perchlorate, Chromium, Arsenic, Copper, Lead as well as Cysts, such as Giardia and Cryptosporidium. Because the process of extracting this high quality drinking water takes time, your RO water treatment system is equipped with a storage tank.

Stage 4- Carbon post filter, recommend change 12 months.

The final stage is a high quality carbon filter. Drinking water enters this filter after the water storage tank and it is used as a final polishing filter.

Note: Filter & Membrane life may vary based upon local water conditions and/or use patterns.

System Maintenance

Just because you can not taste it, does not mean that it is not there. Contaminants such as Lead, Chromium and Arsenic are undetectable to the taste. Additionally, over time if you do not replace the filter elements, other bad tastes and odors will be apparent in your drinking water.

It is important to change out your filters at the recommended intervals as indicated in this system manual. When replacing the filter elements, pay special attention to any cleaning instructions. Should you have any further questions please refer to our web site at www.wattspremier.com or call our customer service department at **1-800-752-5582**.

**** Before installation, please take a moment to fill out the warranty card on page 23.**

With proper installation and maintenance, this system will provide you with high quality water for years to come. All of Watts Premier's water enhancement products are rigorously tested by independent laboratories for safety and reliability. If you have any questions or concerns, please contact our customer service department at 1-800-752-5582 (outside USA 623-931-1977) or refer to our on-line troubleshooting guide at www.wattspremier.com.

Table of Contents

System Overview.....	2
Table of Contents	3
Operational Parameters	4
Contents of Reverse Osmosis System.....	4
Tools Recommended For Installation	4
Drill a Hole for the Faucet in a Porcelain Sink.....	5
Punch a Hole for the Faucet in a Stainless Steel Sink	5
Watts Monitor Faucet Installation	6
Adapt-a-Valve Installation.....	7
Drain Saddle Installation	7
Drill hole and Connect 3/8" Black Tube from Faucet to the Drain Saddle	8
Green Tube Connection (From RO Module To The Adapt-A-Valve).....	8
Reverse Osmosis Module Mounting	8
How To Use Quick Connect Fittings For Tubing Connections.....	9
Red Tube Connection (From The Faucet To The RO Module).....	9
Tank Ball Valve Installation	10
Blue Tube Connection (From The RO Module to the Tank)	10
Blue Tube Connection (From The RO Module to the Faucet).....	10
Start up Instructions	11
Changing The Filter Cartridges	12
Annual Sanitization	13
Procedure for Extended Non-Use	13
Check Air Pressure in the Tank	14
Parts List / Unit Drawing	14
Trouble Shooting	15
Performance Data Sheet.....	16
Arsenic Fact Sheet	17
Other Products from Watts Premier	18-20
Nitrate-Nitrite Test Instruction	21
California Certification	22
Warranty Registration.....	23-24
Service Record	25
Limited Warranty	26

Operational Parameters

Installation must comply with state and local plumbing regulations. This system is intended to be installed on the cold water line only.

Operating Temperatures:	Maximum 100°F (37.8°C)	Minimum 40°F (4.4°C)
Operating Pressure:	Maximum 85 psi (6.0 kg/cm ²)	Minimum 40 psi (2.80 kg/cm ²)
pH Parameters:	Maximum 11	Minimum 2
Iron:	Maximum 0.2 ppm	
TDS (Total Dissolved Solids)	< 1800 ppm	
Turbidity	< 5 NTU	

Hardness: Recommended hardness not to exceed 10 grains per gallon, or 170ppm. System will operate with hardness over 10 grains but the membrane life may be shortened. Addition of a water softener may lengthen the membrane life.

Water Pressure: The operating water pressure in your home should be tested over a 24 hour period to attain the maximum pressure. If the incoming water pressure is above 85 psi a pressure regulator is recommended and if over 100 psi then a pressure regulator is required. Should you need a gauge to check your water pressure, see page 19 (item no. 261003).

Copper Tubing: Reverse Osmosis water should not be run through copper tubing as the purity of the water will leach copper causing an objectional taste in water and pin holes may form in the tubing. Watts Premier supplies speciality filters (part number 107008) that can be used if copper tubing follows the Reverse Osmosis unit. Be sure to follow any state or local regulations during installation.

Contents of Reverse Osmosis (RO) System

- 1 Tank - White
- 1 RO Module (complete with filters)
- 1 Parts Bag
- 1 Faucet Bag
- 1 Manual

If any of the items are missing please contact Watts Premier prior to installing.



Tools Recommended For Installation

- √ 1 1/4" Hole Saw Bit for Faucet opening
- √ Round Knock out Punch for Stainless Sinks 1 1/4"
- √ Adjustable Wrench
- √ Sharp Knife
- √ 1 / 2" Open End Wrench
- √ Phillips Screw Driver
- √ Needle Nose Pliers – Adjustable Pliers
- √ Electric Drill
- √ 1/8", 1/4" & 3/8" Drill Bits



Drill a Hole for the Faucet in a Porcelain Sink

Note: *Most sinks are pre drilled with 1 ½” or 1 ¼” diameter hole that you can use for your RO faucet. (If you are already using it for a sprayer or soap dispenser, see step 1)*

Porcelain sinks are extremely hard and can crack or chip easily. Use extreme caution when drilling. Watts Premier accepts no responsibility for damage resulting from the installation of faucet.

Step 1 Determine desired location for the RO faucet on your sink and place a piece of masking tape on over where the hole is to be drilled. Mark the center of the hole on the tape.

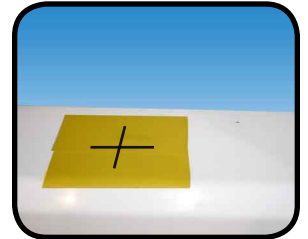

Step 2 Using a variable speed drill set on the slowest speed, drill a 1/8” pilot hole through both porcelain and metal casing of sink at the marked center of the desired location. Use lubricating oil or liquid soap to keep the drill bit cool (If drill bit gets hot it may cause the porcelain to crack or chip).



Step 3 Using a 1 ¼” hole saw, proceed to drill the large hole. Keep drill speed on the slowest speed and use lubricating oil or liquid soap to keep the hole saw cool during cutting.

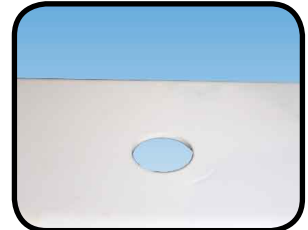

Step 4 Make sure the surroundings of the sink are cooled before mounting the faucet to the sink after drilling and remove all sharp edges.

Punch a Hole for the Faucet in a Stainless Steel Sink

Note: *If mounting faucet to a Stainless Steel Sink you will need a 1 ¼” Hole Punch. The faucet opening should be centered between the back splash and the edge of the sink, ideally on the same side as the vertical drain pipe.*

Step 5 Drill a 1/4” pilot hole. Use a 1/2” Hole Punch and an adjustable wrench to punch the hole in the sink. Change to the 1 ¼” Hole Punch to enlarge the hole.



The faucet can now be installed.



WATTS Premier Monitored & Non-Monitored (Top Mount) Faucet Installation (P/N 116098)

	Minimum	Maximum
Mounting Hole Size	1.00"	1.25"
Torque on Toggle Bolt	5lb.in. (max)	

- Step 6** Remove faucet base & spout from their respective plastic bags. Feed the faucet tubing through the round rubber gasket which you will find in the faucets parts bag. Peel the white backing from the upper side of the gasket and press firmly on to the base of the faucet. From above the sink, feed the faucet tubing & toggle bolt down through the 1¼" mounting hole in the sink.
- Step 7** Peel the white backing from the bottom side of the rubber gasket, align the faucet base so that the handle is on the right side and press the faucet base down firmly over the mounting hole. Turn the handle down (towards you) to the "ON" position to reveal the tightening screw (located where the spout will be inserted). Using a Phillips head screwdriver, turn the screw clockwise until the toggle bolt secures the faucet base snug onto the sink top, do not over torque toggle bolt (5lb.in. max)
- Step 8** Once the faucet base is securely fastened to the sink top, insert the faucet spout into the faucet base until it is fully seated. Turn the handle up (away from you) to the "OFF" position.
- Step 9** Completion of faucet installation (tubing connections) will be done later in this manual.

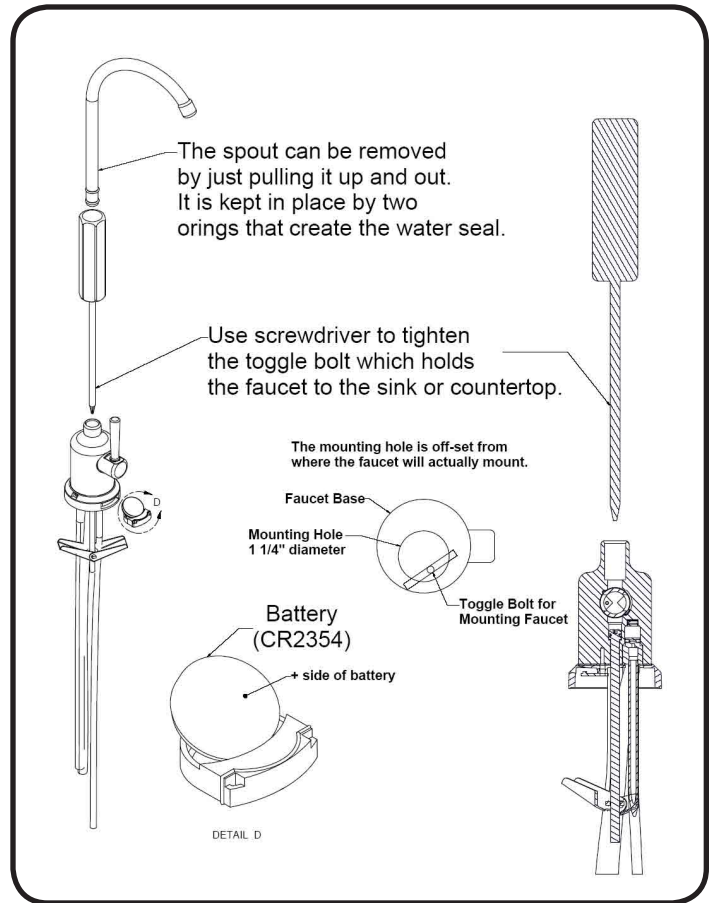

Faucet Battery Installation

- Step 10** Remove the faucet battery from the plastic bag. Locate the faucet battery compartment drawer on the base of the faucet. Use a small screwdriver to pry on the notch at the compartment drawer face and slide the drawer out. Insert the battery into the battery compartment drawer.

NOTE: The + side of the battery faces up. The compartment drawer will not slide in if the battery is installed upside down.

Once the battery is in place, slide the battery compartment drawer back into the base until it is flush.

When the battery is first installed, both the red and green lights will flash to indicate that both lights are functional. Thereafter, it will flash green only when the faucet handle is turned to the "ON" position. When your system is ready to be serviced (approximately six months) you will see the light flash red when the handle is turned to the "ON" position.

NOTE: If your water usage is high the red light may activate sooner than six months indicating the need for filter replacement.

This faucet provides an electronic monitor that will tell you when it is time to replace the filters in your water treatment device. The light indicator will be green for the life of the filter, turning red once the life of the filter has been reached. This can occur after six months of use, or sooner for heavy water usage. The battery life is expected to last one year, however, under heavy use the battery may need to be replaced sooner. For replacement, look for battery number CR2354 (Watts p/n:116082) which should be available at your local battery store or contact Watts Premier at 800-752-5582. You may also order online at www.wattspremier.com.

Adapt-a-Valve Installation - Part# 134007

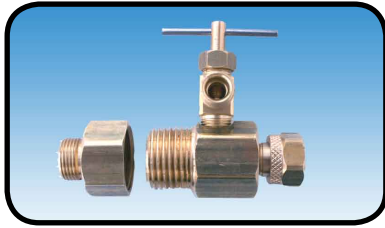

Configuration for 3/8" compression fittings



Hot Supply Cold Supply

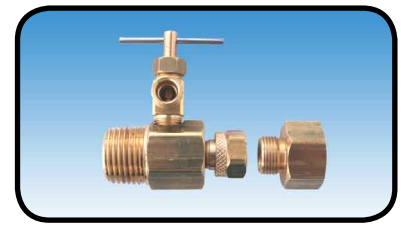

Configuration for 1/2" compression fittings

- Step 11 Turn off the cold water supply to the faucet by turning the angle stop valve completely off.
- Step 12 Attach the adapt-a-valve as illustrated in the three photos above, choosing the configuration that fits your plumbing. (When attaching the adapt-a-valve to straight pipe threads, use Teflon tape on the threads without the rubber washer.)

Caution: *Water supply line to the system must be from the cold water supply line only. Hot water will severely damage your system.*

Drain Saddle Installation - Part# 164016

Drain Saddle fits standard 1 1/4" – 1 1/2" drain pipes

Caution: *If you have a garbage disposal, do not install the drain saddle near it. Installation of the drain saddle must be either above the garbage disposal, or if a second sink drain is available, install it above the cross bar on the second drain. Installation of the drain saddle near a garbage disposal may cause the drain line to plug. If no other installation of drain line is available, Watts Premier offers drain line installation kit (part number 164020) that can be used with garbage disposals.*

- Step 13 Gather the pieces of the drain saddle
- | | |
|-------------------------|-----------------------------------|
| 1 Black compression nut | 1 Semicircle bracket with opening |
| 2 Screws | 1 Foam gasket |
| 2 Nuts for screws | 1 Semicircle bracket |
- Step 14 The small square black foam gasket with a circle cut out of the middle must be applied to the inside of the drain saddle. Remove sticky tape backing and stick to the drain saddle as shown.
- Step 15 The drain saddle must be mounted at least 1 1/2" above the nut of the P-trap or cross bar from the garbage disposal to insure proper drainage. Assemble the drain saddle around the drain pipe at the best available location. Using Phillips screw driver tighten screws evenly and securely on both sides of the drain saddle. Keep the plastic compression nut off at this time.

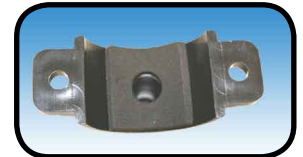
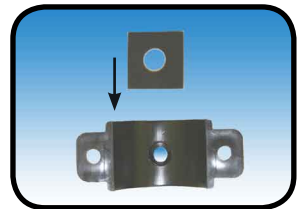
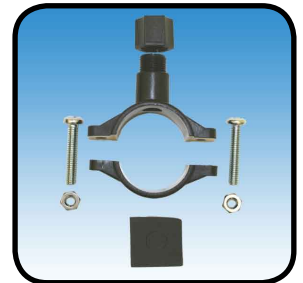

Caution: *Do not over tighten the screws. It may crack the drain saddle.*

Drill hole and Connect 3/8" Black Tube from Faucet to the Drain Saddle

IMPORTANT:

The black 3/8" drain tube must be as SHORT and STRAIGHT as possible to the drain saddle, making a downward slope from faucet to drain saddle to allow for proper drainage. This is a gravity fed line and if there is any bend or dip in the tube, the rinse water will not flow into the drain properly. Water may back up and come out the air gap hole in the back of the faucet.

Step 16 With the drain saddle secured onto the drain pipe, using a 1/4" drill bit installed in your electric drill, insert the drill bit through the opening in the drain saddle and drill through the drain pipe.

Caution: It is very important to keep the drill centered to prevent damage of the drain saddle while drilling.

Step 17 Measure the 3/8" black tube from faucet to the drain saddle on the drain pipe and make a straight cut to the correct length.

Step 18 Slip black tube through black compression nut. Insert black tube into the opening in the drain saddle and hand tighten the black nut, and add 1/4 turn with a wrench.



Green Tube Connection

Step 19 Locate green tube from the RO Module. Remove a brass nut, plastic sleeve and brass insert from the parts bag. To assemble, place the brass nut on the green tube first, then the sleeve (small tapered end of sleeve must point to the end of tube) and then push the brass insert all the way into the end of the tube. (See Picture)

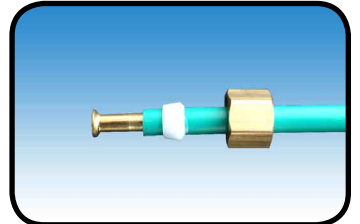

Step 20 Insert the green tube into the 1/4" opening on the adapt-a-valve until it stops. Slide the brass nut and sleeve down and thread onto the male pipe threads. Use a 1/2" wrench to securely tighten the nut.

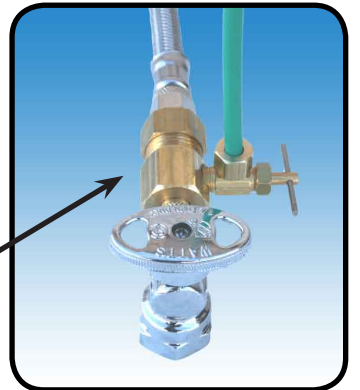

Adapt-a-Valve - Part # 560070

Reverse Osmosis Module Mounting

Step 21 Determine best location for the RO module to be mounted to allow for future system maintenance. The parts bag has 2 self tapping screws. Using an electric drill with a Phillips bit, screw them into the cabinet wall 6" apart and 16" from the bottom of the cabinet.

Note: Do not cut any RO system tubes at this time



How To Use the Quick Connect Fittings on the RO Module

To make a connection, the tube is simply pushed into the fitting. The unique patented John Guest® locking system holds the tube firmly in place without deforming it or restricting flow.

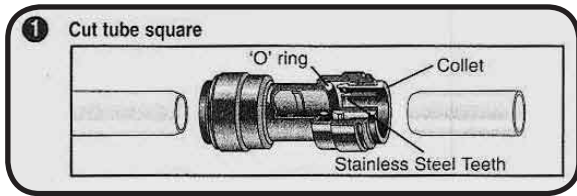

It is essential that the outside diameter be free of score marks and that burrs and sharp edges be removed before inserting into fitting.

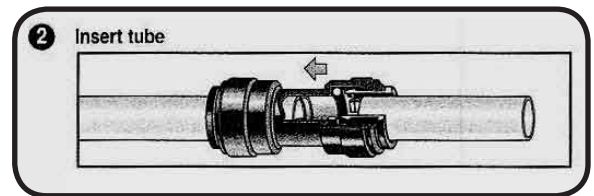

Fitting grips before it seals. Ensure tube is pushed into the tube stop.

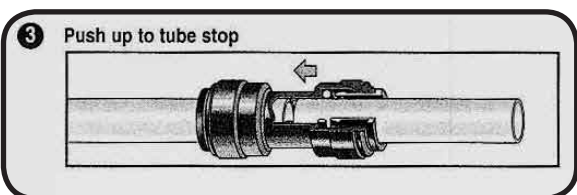

Push the tube into the fitting, to the tube stop. The collet (gripper) has stainless steel teeth which hold the tube firmly in position while the O-ring provides a permanent leak proof seal.

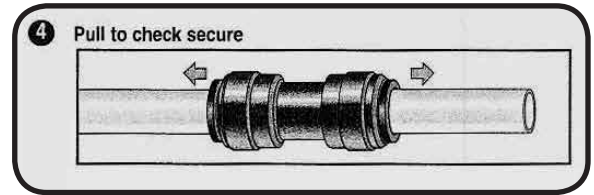

Pull on the tube to check that it is secure. It is a good practice to test the system prior to leaving site and /or before use.

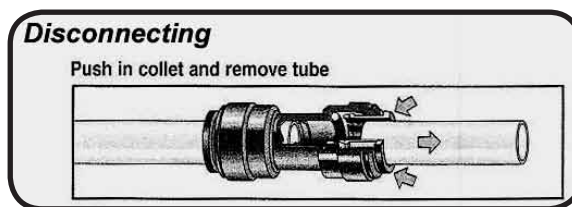

To disconnect, ensure the system is depressurized before removing the tube. Push in collet squarely against face of fitting. With the collet held in this position, the tube can be removed. The fitting can then be reused.

Red Tube Connection (From FAUCET To The RO Module)

Step 21 Determine where the 1/4" red tubing from the faucet and the open end of the 1/4" quick connect fitting (located on the left side of the RO module) would join together comfortably. Cut the red tube to length, making sure the cut is straight and square. Insert the red tube into the open end of the 1/4" quick connect fitting making sure the tube is pushed in all the way to the tube stop.



Tank Ball Valve Installation - Part#: 134018

Step 22 Teflon tape must be applied in a clockwise direction. Wrap (7 to 12 turns) around the male pipe threads (MPT) on the stainless steel fitting on top of the tank.

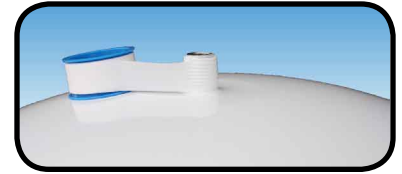

Step 23 Thread the quick connect ball valve (supplied in the parts bag) onto the stainless steel connector on the tank.

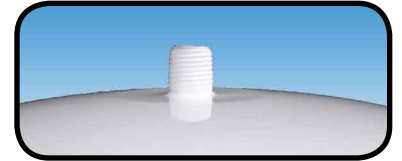

Note: Do not over-tighten plastic connections.

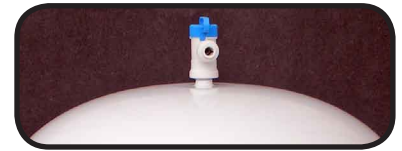

Blue Tube Connection (From The RO Module To TANK)

Step 24 Position tank in desired location. Stand it upright or lay it on its side (using the black plastic stand). Measure the blue tube (marked "TANK") from the RO module to the tank and cut it to length leaving a straight, square edge. Insert the tube into the quick connect fitting on the tank ball valve. Make sure the tube is pushed in all the way to the tube stop (see page 9 for quick connect fitting use directions).

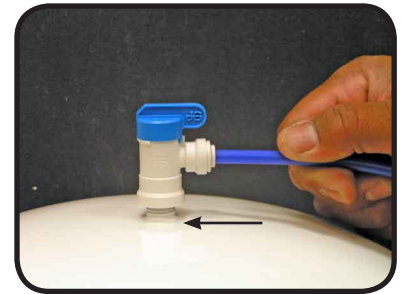

Blue Tube Connection (From The RO Module To FAUCET)

Step 25 Determine where the 3/8" blue tubing from the faucet and the 1/4" blue tubing (marked "FAUCET") from the RO Module would join together comfortably. Cut the tubes leaving a straight cut on both tubes. Insert the 1/4" blue tube (marked "FAUCET") from the RO module into the 1/4" end of the 1/4" x 3/8" quick connect union supplied in the parts bag. Make sure the tube is pushed in all the way to the tube stop.

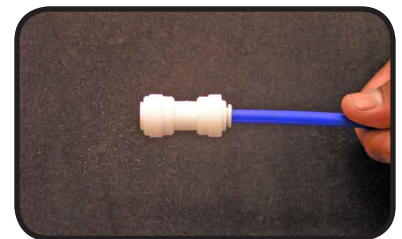

Step 26 Insert the 3/8" blue tube from the faucet into the 3/8" open end of the 1/4" x 3/8" quick connect union. Make sure the tube is pushed in all the way to the tube stop.

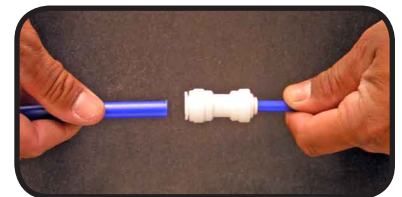

Note: A connection to a refrigerator / ice maker may be tee'd into this blue tube. Watts Premier offers an ice maker install kit part # 500010 (See Page 18).

Congratulations!

You have completed the installation of new your Reverse Osmosis system.

Please Follow the Startup Instructions.

Start up Instructions

- Step 1 Turn on the incoming cold water at the angle stop valve. Open the needle valve on the brass Adapt-a-Valve by turning counter clockwise. Check the system for leaks and tighten any fitting as necessary. Make sure that the ball valve on top of the storage tank is in the open position - blue handle is in line with the blue tube.
(Check frequently over the next 24 hours to ensure no leaks are present).
- Step 2 If you have connected your RO system to a refrigerator / ice maker, make sure the ice maker is off (do not allow water to flow to the ice maker) until flushing (Step 5) is complete and the tank has been allowed to completely fill. Connection from the RO to the ice maker system should have an in-line valve installed before the ice maker so it can easily be closed to prevent water flowing to the ice maker during start up and periodic maintenance. Your RO tank must be allowed to fill up fully in order for the ice maker system to work properly.
- Step 3 Open the RO faucet and leave it open until water begins to trickle out (it will come out slowly).
- Step 4 Close the RO faucet allowing the storage tank to fill with water. It may take 4 to 6 hours to fill the tank completely depending on the production capability of the membrane, local water temperature and water pressure.
- Note:** *During the fill period you may hear water trickling due to the Reverse Osmosis Process.*
- Step 5 After the Tank has filled, open the RO Faucet to flush the tank completely. You will know that the tank is empty when the flow rate from the RO faucet is down to a trickle. Repeat this step two more times. The fourth tank can be used for drinking.

Note: *Flushing of the tank 3 times is only necessary during the initial startup and after replacing the membrane.*

Don't Forget To Register!

Register by mail, phone, fax or internet. Watts Premier uses this information only to provide a filter change reminder notice. Pre-filters should be changed every 6 months and the Post Carbon filter annually. You may register your warranty via our web site at www.wattspremier.com or call 1-800-752-5582 (within USA only) / FAX#: 623-931-0191. For Warranty card Please see page 23-24.

Changing The Filter Cartridges

Your RO module is equipped with valved heads which will automatically turn off the water supply to each filter when the filter is released, thus you do not need to turn off the incoming water supply at the Adapt-a-Valve. The RO faucet must be off when filters are replaced. To make the removal of the filter cartridges easier, the heads & cartridges may be swiveled up to 90 degrees as shown in the pictures below.

Step 1 Place a towel under the RO module to catch any excess water that may drip out from the filters during the changeover.

Step 2 To remove a filter cartridge: Push & hold the button on the valved head above the filter. Pull cartridge downward (from the head) to remove. Release button and discard old filter.

Step 3 To install a filter cartridge: Remove the seal cap and insert the cartridge into the valved head until you hear an audible “click” (the button does not need to be pressed to install new filters).

Note: To reset the electronic monitor during replacement of filters, simply slide out the battery from the base of the faucet and reinsert.



6 Month System Maintenance

Replace: √ One sediment filter (Red Label P/N: 105311)
 √ One carbon pre-filter (Yellow Label P/N: 105351)

Annual Maintenance -(Sanitization Recommended See PG.13)

Replace: √ One sediment filter (Red Label P/N: 105311)
 √ One carbon pre-filter (Yellow Label P/N: 105351)
 √ One carbon post-filter (Blue Label P/N: 105341)

Tip: This is a good time to check the air pressure in your storage tank. For instructions please see page 14.

Note: Flush first tank full after completing the annual maintenance.

This reverse osmosis system contains a replaceable component (the RO membrane) which is critical to the efficiency of the system. Replacement of this reverse osmosis membrane should be with one of identical specifications as defined by Watts Premier to assure the same efficiency and contaminant reduction performance.

Membrane Replacement (2 - 5 Years)

Replace: √ One Membrane (Green Label P/N: 105331)

Membranes have a life expectancy between 2 and 5 years, depending on the incoming water conditions and the amount the RO system is used. This reverse osmosis membrane is critical for effective reduction of total dissolved solids (TDS). The product water should be tested periodically to verify that the system is performing satisfactorily.

Normally, a membrane would be replaced during a semiannual or annual filter change. However, if at any time you notice a reduction in water production or an unpleasant taste in the reverse osmosis water, it could be time to replace the membrane. Watts Premier recommends replacing the membrane when TDS reduction falls below 75%.

A water sample may be sent to Watts Premier for a free diagnosis of your membranes performance. To send a water sample, use 2 clean containers and fill 1/2 cup of tap water in one container and 1/2 cup of RO water in 2nd container. Clearly label each sample. Send the samples to the address listed on the cover of this manual attention “Water Samples”. Watts Premier will test the water and mail or call you with the results.

Annual Sanitization

Note: *Sanitization procedure should be performed before a filter change.*

Step 1 Turn off the water supply to your RO system by turning the “T” on the adapt-a-valve clockwise until it stops and open the RO faucet to drain the storage tank.

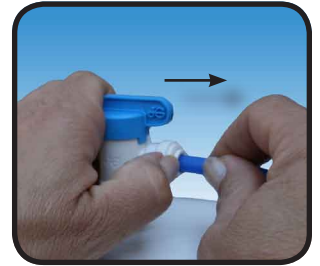

Step 2 Disconnect the blue tube from the ball valve on the storage tank (see page 9 for quick connect fitting use directions).

Step 3 Using a clean eye dropper insert ½ teaspoon of hydrogen peroxide or common household bleach into the blue tube. This will flow into the tank once water is turned back on to unit. Reattach blue tube to the ball valve. Follow start up procedure and drain the first two full tanks of water.



Procedure for Extended Non-Use (More than 2 months)

Turn off the water supply to your RO system by turning the “T” on the adapt-a-valve clockwise until it stops and open the RO faucet to drain the storage tank. Once the storage tank is empty, remove all filter cartridges (order not important), place them into a sealed plastic bag and store in your refrigerator.

To Restart System:

Step 1 Reinstall all filters on to the RO unit. Filters are color coded to match the filter heads they snap in to. Refer to page 12 step three for cartridge installation procedure.

Step 2 Open the needle valve on the brass Adapt-a-Valve by turning counter clockwise. (Check frequently over the next 24 hours to ensure no leaks are present).

Note: *If you have connected your RO system to a refrigerator / ice maker, make sure the ice maker is off (do not allow water to flow to the ice maker) until the tank has been allowed to completely fill.*

Step 4 Open the RO faucet and leave it open until water begins to trickle out (it will come out slowly).

Step 5 Close the RO faucet allowing the storage tank to fill with water. It may take 4 to 6 hours to fill the tank completely depending on the production capability of the membrane, local water temperature and water pressure.

Step 6 After the Tank has filled, open the RO Faucet to flush the tank completely. You will know that the tank is empty when the flow rate from the RO faucet is down to a trickle. The second tank can be used for drinking.

Check Air Pressure in the Tank

Important: Check air pressure only when tank is empty of water!

Check air pressure in the storage tank when you notice a decrease in available water from the RO system. Air can be added with a bicycle pump using the schrader valve that is located on the lower side of the tank behind a blue plastic cap.

Step 1 Turn off the incoming water supply to the RO by turning the needle valve on the adapt-a-valve clockwise until it stops. (Follow the green tube away from the RO system to find the adapt-a-valve.)

Step 2 Open the RO Faucet and allow water to drain from the tank until it is completely empty.



Tip: When water from the RO faucet slows to a trickle, with the faucet still in the open position, you may add air to the tank to purge any left over water, this will ensure that the tank is completely empty.

Step 3 Once all water in the tank is purged, check air pressure using an air pressure gauge, it should read between 5 - 7 PSI. (Digital air pressure gauge is recommended)

Parts List

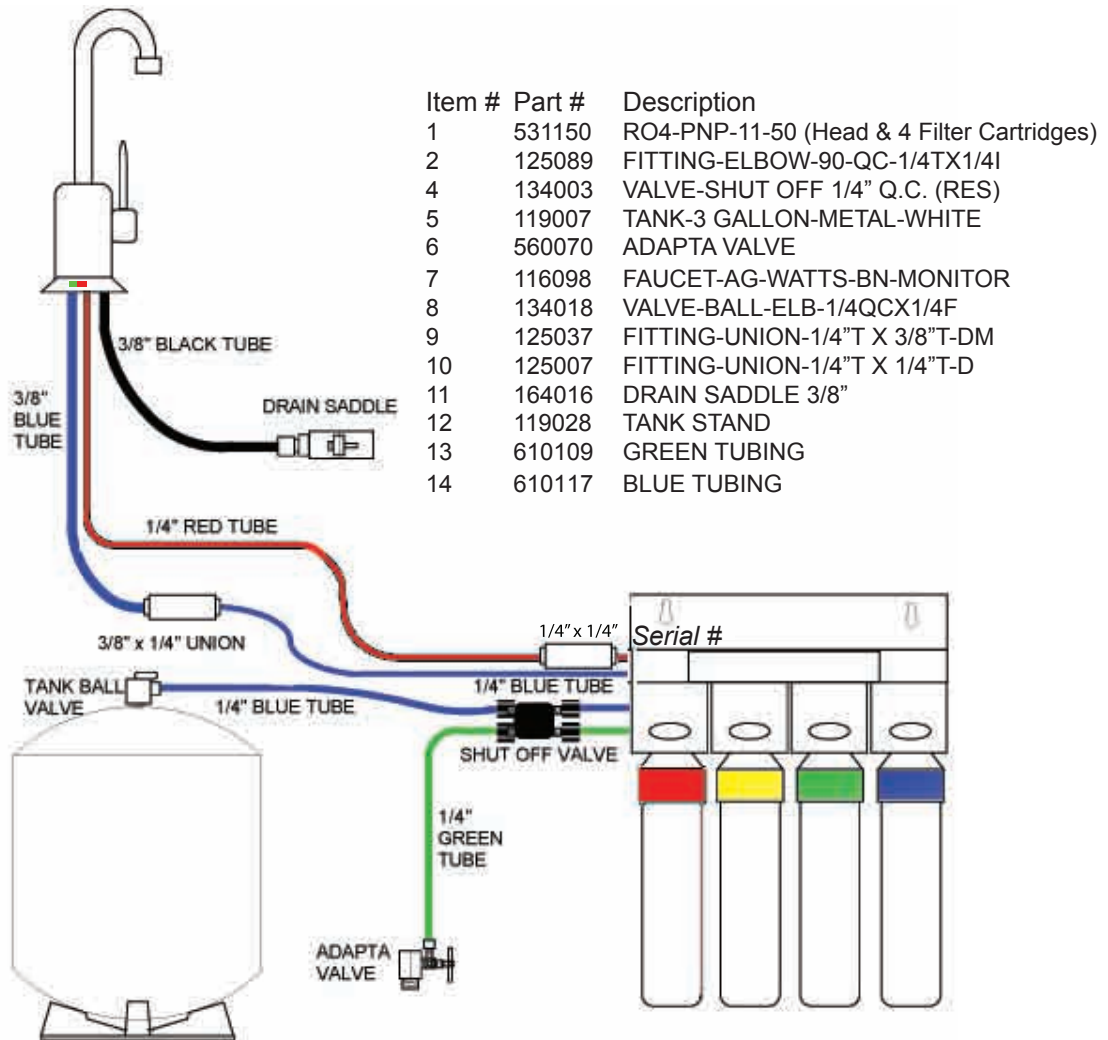

TROUBLE SHOOTING

Problem	Cause	Solution
1. Low/Slow Production	<p>Low Water Pressure</p> <p>Crimps in tubing Clogged pre-filters Fouled membrane</p>	<p>Assure a minimum of 40 psi incoming water pressure. Premier sells a booster pump if home water pressure is low. Make sure water supply is turned on and Adapta Valve is all the way open.</p> <p>Check tubing and straighten or replace as necessary. Replace pre-filters. Replace membrane.</p>
2. Milky colored Water	Air in system	Air in the system is a normal occurrence with initial start up of the RO system. This milky look will disappear during normal use within 1-2 weeks. If condition reoccurs after filter change, drain tank 1 to 2 times.
3. Water constantly running, unit will not shut off	<p>Low water pressure</p> <p>Crimp in supply tube High water pressure</p> <p>High pressure in Tank</p> <p>Low Pressure in Tank</p>	<p>See #1 Above</p> <p>Check tubing and straighten or repair as necessary. Check incoming water pressure to make sure it does not exceed 80 psi. A pressure relief valve may be necessary.</p> <p>Empty storage tank of water. Set tank air pressure between 5-7 psi. See previous page.</p> <p>Use a Digital Air Gauge for best results. The empty tank pressure should be 5-7 psi. See page 14.</p>
4. Noise / Water from faucet vent hole or noise from drain.	<p>Crimp or restriction in drain line</p> <p>Drain tube clogged</p>	<p>Check tubing and straighten or repair as necessary. Straighten all drain lines. Clear blockage. Cut off any Excess tubing</p> <p>Caused from dishwasher or garbage disposal. Disconnect the 3/8" black line at the drain, clean the 3/8" black line out with a wire, then reconnect. Blowing air through the line will not always remove the clog.</p>
5. Small amount of water in storage tank	<p>System starting up</p> <p>Low water pressure To much air in tank</p>	<p>Normally it takes 4-6 hours to fill tank. Note: low incoming water pressure and/or temperature can drastically reduce production rate.</p> <p>See #1 above.</p> <p>Tank air pressure should be 5-7 psi when empty of water. If below 5 psi add air or bleed if above 7 psi. Check only when tank is empty of water. See previous page.</p>
6. Water leaks from the filter / membrane cartridge.	Not properly seated	Re-insert the filter / membrane cartridge.
7. Low water flow from faucet	Check air pressure in tank	Use a Digital Air Gauge for best results. The empty tank pressure should be 5-7 psi. See page 14.

Watts Premier Inc.
1725 W. Williams Drive C-20
Phoenix, AZ 85027 USA
California Certification # 07-1882
RO-Pure

System conforms to NSF Standard 58 for specific claims.

GENERAL USE CONDITIONS:

1. System to be used with municipal or well water sources treated and tested on regular basis to insure bacteriological safe quality. DO NOT use with water that is microbiologically unsafe or unknown quality without adequate disinfection before and after the system. Systems certified for cyst reduction may be used on disinfected water that may contain filterable cysts.
2. This system is acceptable for treatment of influent concentrations of no more than 27 mg/L nitrate and 3 mg/L nitrite in combination measured as N and is certified for nitrite/nitrate reduction only for water supplies with a pressure of 280 kPa (40 psig) or greater. If your water supply is under 40 psi Watts Premier recommends the use of a RO booster pump for proper operation.
3. Operating Temperature: Maximum: 100°F (40.5°C) Minimum: 40° (4.4°)
4. Operating Water Pressure: Maximum: 85 psi (6.0kg/cm2) Minimum: 40 psi (2.8kg/cm2)
5. pH 2 to 11
6. Maximum Iron present in incoming water supply must be less than 0.2 ppm.
7. Hardness of more than 10 grains per gallon (170 ppm) may reduce RO membrane life expectancy.
8. Recommend TDS (Total Dissolved Solids) not to exceed 1800 ppm.



RECOMMENDED REPLACEMENT PARTS AND CHANGE INTERVALS:

Note: Depending on incoming feed water conditions replacement time frame may vary.

Description	Change time Frame	Cost
Sediment Pre-filter: #105311	6 Months	\$ 9.95
Carbon Pre-filter: #105351	6 Months	\$15.95
Final Carbon filter #105341	12 Months	\$15.50
R.O. Membrane: #105331	2 to 5 years	\$99.00

* All Prices Subject to change without notice



This system has been tested according to NSF/ANSI 58 for reduction of the substances listed below. The concentration of the indicated substances in water entering the system was reduced to a concentration less than or equal to the permissible limit for water leaving the system as specified in NSF/ANSI 58. This system has been tested for the treatment of water containing pentavalent arsenic (also known as As (V), As (+5), or arsenate) at concentrations of 0.30 mg/L or less. This system reduces pentavalent arsenic, but may not remove other forms of arsenic. This system is to be used on water supplies containing a detectable free chlorine residual at the system inlet or on water supplies that have been demonstrated to contain only pentavalent arsenic. Treatment with chloramine (combined chlorine) is not sufficient to ensure complete conversion of trivalent arsenic to pentavalent arsenic. Please see the Arsenic Facts section of the Performance Data Sheet for further information.

	Avg. In. (mg/L)	Avg. Eff. (mg/L)	% Reduction	pH	Pressure	Max Eff. mg/L	Inf. challenge concentration mg/L	Max Allowable concentration mg/L
Arsenic (Pentavalent)	.310	0.001	99.6%	7.24	50psi	0.002	0.30±10%	0.010 mg/L
Barium Reduction	9.2	0.08	99.0%	7.64	50psi	0.12	10.0±10%	2.0
Cadmium Reduction	0.031	0.0004	98.0%	7.49	50psi	0.0008	0.03±10%	0005
Chromium (Hexavalent)	0.30	0.002	99.0%	7.24	50psi	0.004	0.03±10%	0.1
Chromium (Trivalent)	0.30	0.001	99.0%	7.64	50psi	0.002	0.03±10%	0.1
Copper Reduction	3.2	0.02	99.0%	7.40	50psi	0.04	3.0±10%	1.3
Cysts	92,000#/ml	3 #/ml	99.99%	7.44	50psi	18	minimum 50,000/mL	N/A
Fluoride Reduction	8.7	0.19	97.0%	7.24	50psi	0.3	8.0±10%	1.5
Lead Reduction	0.15	0.002	98.8%	7.39	50psi	0.005	0.15±10%	0.0107
Nitrate	27	3.8	86.0%	7.24	50psi	4.3	27.0 ±10%	10.0
Nitrite	3.1	0.41	86.0%	7.24	50psi	0.46	3.0 ±10%	1.0
Nitrate + Nitrite	30	4.2	86.0%	7.24	50psi	4.8	30.0 ±10%	10.0
Perchlorate	0.14	0.003	97.0%	7.39	50psi	0.005 mg/L	0.10±10%	0.006
Radium 226/228	25pCi/L	5pCi/L	80.0%	7.24	50psi	5pCi/L	25pCiL±10%	5pCiL
Selenium	94.85	<0.2	97.0%	7.24	50psi	<0.2	0.10±10%	0.05
TDS	741	22	97.0%	7.28	50psi	26.0	750±40mg/L	187
Turbidity	11.3	0.1	99.0%	7.43	50psi	0-1	11±1mg/L	0.5NTU

Recovery - 15.77%

Daily Production Rate - 18.43 GPD

Efficiency - 8.82%

Depending on water chemistry, water temperature, and water pressure Watts Premier's R.O. Systems production and performance will vary. Efficiency rating means the percentage of the influent water to the system that is available to the user as reverse osmosis treated water under operating conditions that approximate typical daily usage. Recovery rating means the percentage of the influent water to the membrane portion of the system that is available to the user as reverse osmosis treated water when the system is operated without a storage tank or when the storage tank is bypassed. There is an average of 4 gallons of reject water for every 1 gallon of product water produced.

REFER TO OWNER'S INSTALLATION/SERVICE MANUAL FOR FURTHER MAINTENANCE REQUIREMENTS AND WARRANTY INFORMATION.

Phone: (623) 931-1977

Fax: (623) 931-0191

Email: wpmail@watts.com

Arsenic Fact Sheet

Arsenic (As) is a naturally occurring contaminant found in many ground waters. Arsenic in water has no color, taste or odor. It must be measured by an arsenic test kit or lab test.

Public water utilities must have their water tested for arsenic. You can obtain the results from your water utility contained within your consumer confidence report. If you have your own well, you will need to have the water evaluated. The local health department or the state environmental health agency can provide a list of test kits or certified labs.

There are two forms of arsenic: pentavalent arsenic (also called As (V), As (+5)) and trivalent arsenic (also called As (III), As (+3)). In well water, arsenic may be pentavalent, trivalent, or a combination of both. Although both forms of arsenic are potentially hazardous to your health, trivalent arsenic is considered more harmful than pentavalent arsenic.

RO systems are very effective at removing pentavalent arsenic. A free chlorine residual will rapidly convert trivalent arsenic to pentavalent arsenic. Other water treatment chemicals such as ozone and potassium permanganate will also change trivalent arsenic to pentavalent arsenic. A combined chlorine residual (also called chloramine) where it does convert trivalent arsenic to pentavalent arsenic, may not convert all the trivalent arsenic in to pentavalent arsenic. If you get your water from a public water utility, contact the utility to find out if free chlorine or combined chlorine is used in the water system.

This Watts Premier reverse osmosis system is designed to remove up to 98% of pentavalent arsenic. It will not convert trivalent arsenic to pentavalent arsenic. Under laboratory standard testing conditions, this system reduced 0.30 mg/L (ppm) pentavalent arsenic to under 0.010 mg/L (ppm) (the USEPA standard for drinking water). Actual performance of the system may vary depending on specific water quality conditions at the consumer's installation. In addition to the independent laboratory standard testing conditions Watts Premier has conducted additional field testing on our reverse osmosis units to determine trivalent arsenic reduction capabilities. Based upon Watts Premier field testing, it has been determined that the RO units are capable of reducing up to 67% of trivalent arsenic from the drinking water.

The RO membrane component of this Watts Premier reverse osmosis system must be maintained according to its recommended maintenance cycle. Specific component identification and ordering information can be found in the installation/operation manual maintenance section, by phone at 1-800-752-5582 or online www.wattspremier.com

California Proposition 65 Warning

WARNING: this product contains chemicals known to the State of California to cause cancer and birth defects or other reproductive harm. (Installer: California law requires that this warning be given to the consumer). For more information: www.watts.com/prop65.

Other Products from Watts Premier

Watts Premier has other fine water filtration products and accessories to enhance your water and to compliment your existing RO System. Listed on the next several pages are only a few of the items we offer. Visit our web site at www.wattspremier.com or call our Customer Service Representatives at 1-800-752-5582 (inside USA) 1-623-931-1977 (outside USA) for more products.

Watts Premier sells a filter change kit which includes all replacement filters needed. Call 1-800-752-5582 or buy on-line at www.wattspremier.com.



Top Mount Faucets by Watts Premier

These attractively designed faucets feature a long reach spout to compliment all styles of kitchen decor. The unique top mount design allows for easy above counter installation. The Monitored version of this faucet has an LED light that turns red to notify you for filter replacement.

Part No. 116000 - Chrome (Non-Monitored)	*\$49.95 each
116072 - Brushed Nickel (Non-Monitored)	*\$59.95 each
116074 - Chrome (Monitored)	*\$69.95 each
116098 - Brushed Nickel (Monitored)	*\$79.95 each



1/4 inch connection includes 30 feet of 3/8" tubing, ball valve, and fittings.

Part No. 500010 ***\$ 16.95/ea**



Watts Premier Hot Water Recirculation System

Bring convenience and saving to your home, giving you hot water instantly at every faucet, when you need it. This unique product is easy to install and not only provides you with the convenience of hot water when you need it, but saves an average of over 15,000 gallons per year.

Part No. 500800 ***\$229.99 each**



PERMEATE PUMP KIT

Using only the available energy from the brine water (otherwise lost to the drain), the pump forces product water into the storage tank. This process effectively reduces membrane back pressure to less than 5 psi and allows the membrane to maximize its use of the available feed pressure.

- Fills product tank up to 4 times more rapidly
- Reduces waste water by as much as 80%
- Lowers "TDS creep"
- NSF approved (Standard 58)

Part No. 560041 ***\$65.95/ea**

****All prices subject to change without notice.***



RO-PURE Six Month Filter Kit

Compatible with the Watts Premier RO-PURE Reverse Osmosis filtration system. This kit includes one sediment filter and one 5 micron carbon pre filter.

Part No. 531102

***\$24.95/ea**



Pool Doc Pool & Spa Water Tester

PoolDoc™ accurately measures pool and spa chemistry and provides instructions on how to bring the pool/spa back into balance.

Part No. 164040

***\$189.99/ea**



Water Pressure Gauge

This gauge mounts onto your outside hose connection to accurately show your home's water pressure up to 300 psi. A red needle shows peak overnight pressure, which may exceed readings during the day. High pressure readings may indicate the need for a pressure regulator to prevent damage to appliances.

Part No. 261003

***\$11.50/ea**



Pocket Total Dissolved Solids (TDS) Monitor

Test water electronically to verify reverse osmosis membrane effectiveness. Carrying case included.

Part No. 273001

***\$39.95/ea**



Whole House High Performance Water Pressure Regulator

Provides water pressure control solutions for residential, commercial, and industrial applications. Offers durability and years of continuous trouble free operation.

Part No. 107001

***\$69.95 each**



Whole House Filter

Great for sediment problems such as in well water supply or areas where dirt and rust particles are a problem. Includes three 50 micron sediment filters and wrench

(3/4" ports)

Part No. 500223

***\$42.95/ea**

Replacement filter

Part No. 304007

***\$ 4.50/ea**

*** All prices subject to change without notice.**

Removing chlorine from your shower

Special Chlorgon & KDF media – More effective than carbon medias with hot water applications in the removal of the following.

- √ Free Chlorine (CL-)
- √ Combined Chlorine (Sodium Hypochlorite)
- √ Hydrogen Sulfide (Rotten egg smell)
- √ Plus, its pH balanced.
- √ Iron oxide (rust water)
- √ Dirt, sediment
- √ Odors



Deluxe Shower Handle with Built in Filter

5-Way Massaging Spray
72" Reinforced Hose
High Strength Bracket
Triple Plated Finish
Reversible Filter Cartridge (Model HHC)
Cartridge Life Rating: 3 months

Part No. 107070 WHITE *\$38.95
Part No. 107091 CHROME *\$44.95
Part No. 107092 GOLD *\$44.95

Replacement filters 2PK



Part No. 107075 *\$15.95/pk



Shower Falls Deluxe Shower Handle with Built in Filter

Curved Ergonomic Shower Handle
Filter Handle Extension
Dual Swivel Adjustment
Ultra Deluxe 5 Way Massaging Spray
72" Reinforced Hose
Chrome Plated Brass Bracket & Swivel Ball Extension
Triple Plated Finish
Reversible Filter Cartridge (Model HHC)
Cartridge Life Rating: 3 months

Part No. 107095 CHROME *\$55.95

Replacement filters 2PK



Part No. 107075 *\$15.95/pk



All-In-One reversible High-Flow Filter

Deluxe 5-Way Massaging Spray

Soft-Touch Adjustment Pads
Anti-Scaling Spray Nozzle
High Strength Housing
Triple Plated Finish
Cartridge Life Rating: 6 months

Part No. 107098 White/Chrome *\$39.95

Replacement filter



Part No. 107080 *\$13.95/ea

***All prices subject to change without notice.**

Nitrate / Nitrite Test Instruction

This Reverse Osmosis water filtration system has been designed to remove Nitrates and Nitrites from your drinking water. This unit has also been tested and certified by NSF International the leading not-for-profit certification agency for the reduction of incoming concentrations of not more than 27 mg/L nitrate and 3 mg/L nitrite to below safe drinking water levels with a minimum water pressure of 40psi (280kPa). In order for this water treatment device to operate as designed, it is important that it is properly installed and maintained as detailed in the installation and operation manual. The installation of a booster pump to this reverse osmosis unit is suggested in the event your incoming water pressure is below 40 psi.

It is recommended that you periodically test the drinking water coming from your reverse osmosis unit to ensure it continues to work properly. In order to ensure proper reduction of Nitrates and Nitrites from your drinking water, a personal nitrite/nitrate test strip has been included for you to use. Fill a clean glass with RO water and submerge the test strip for 2 seconds. Remove the test strip from the water and wait one minute. **Compare the colors on the test strip that you submerged in the water against the color chart on the packaging of the test strip.** The levels obtained during your test should be below the regulated levels of 10.0 mg/L of Nitrate and 1.0 mg/L of Nitrite.

Test Strip Reference

FRONT

NO₃-N + NO₂-N = Nitrate (Total as N)
(EPA Maximum limit = 10ppm Nitrate as N)

NO₃ + NO₂ = Nitrate (Total)
(WHO Maximum limit = 50ppm Nitrate)

NO₂-N = Nitrite as N
(EPA Maximum limit = 1ppm Nitrite as N)

NO₂ = Nitrite
(WHO Maximum limit = 3ppm Nitrite)

2002 MADE IN USA R026-NNFP

Acceptable Range

ppm (mg/L) 0 / 0	2 / 10	10 / 50	20 / 100	50 / 200
ppm (mg/L) 0 / 0	0.3 / 1	0.5 / 2	1 / 3	3.0 / 10

Acceptable Range

BACK

MADE IN USA
Use By:
EXP DATE

Nitrate / Nitrite Test Strip

To Test: Dip in water 2 seconds, remove. After 1 minute match colors and record results within 1 minute.
Contains One Test Strip Store below 80° F (27° C)

OPEN →

For questions, additional test strips or replacement parts for your reverse osmosis, please call us at 800-752-5582

State of California
Department of Public Health
Water Treatment Device
Certificate Number

07 - 1882

Date Issued: September 21, 2007

Trademark/Model Designation

RO-Pure 531401/533401

Replacement Elements

105351 Sediment Pre-Filter
105351 Carbon Pre-Filter
105331 RO Membrane
105341 Carbon Post-Filter

Manufacturer: Watts Premier

The water treatment device(s) listed on this certificate have met the testing requirements pursuant to Section 116830 of the Health and Safety Code for the following health related contaminants:

Microbiological Contaminants and Turbidity

Cysts

Organic Contaminants

None

Inorganic/Radiological Contaminants

Arsenic¹
Barium
Cadmium
Chromium (hexavalent)
Chromium (trivalent)
Copper
Fluoride
Lead
Nitrate / Nitrite²
Perchlorate
Selenium

Rated Service Capacity: N/A

Rated Service Flow: N/A

Conditions of Certification:

Do not use where water is microbiologically unsafe or with water of unknown quality, except that systems certified for cyst reduction may be used on disinfected waters that may contain filterable cysts.

¹ Claims for arsenic reduction shall only be made on water supplies maintaining detectable residual free chlorine at the reverse osmosis (RO) system inlet. Water systems using an in-line chlorinator should provide a minimum of 1 minute chlorine contact time before the RO system.

² This system is acceptable for treatment of influent concentrations of no more than 27 mg/L nitrate and 3 mg/L nitrite in combination measured as N and is certified for nitrate/nitrite reduction only for water supplies with a pressure of 280 kPa (40 psig) or greater. A sampling and analysis test kit for nitrate is provided for checking the performance of this system. Frequent analysis is encouraged.

WARRANTY REGISTRATION

Thank you for selecting Watts Premier for your water filtration needs.

4 Ways to Register

1. On-line at www.wattspremier.com

Register your product on-line and receive a 5% discount on your next on-line order, Plus receive reduced shipping.

2. Call in your information 1-800-752-5582

Call and we will enter your information.

3. Fax in your information 623-931-0191

Fax this form directly to us.

4. Mail in the information.

Please complete the form below. Mail to: **Watts Premier**
1725 W. Williams Dr. C-20
Phoenix, AZ 85027

Registering
will insure you
receive Watts

FREE

Filter
Reminder
Notice

Watts Premier Inc. is concerned for the safety of your personal information. Watts Premier collects personal information when you register with Watts Premier. This information is stored in our data base and we do not rent, sell, or share personal information with other people or nonaffiliated companies. We reserve the right to send you certain types of communications such as direct mail, email, or by telephone relating to our products or products that you have purchased. We limit access to your personal information to those employees who will directly provide you with services or products in order to do their jobs. We want to offer you four ways to communicate with us. 1. Online, 2. Fax, 3. Telephone, and 4. Mail the form below. By registering your product you will receive the full benefit of our warranty. Watts Premier will also send you a semiannual filter change reminder beginning six months from date of installation. To insure the highest quality of your water, filters should be replaced every 6 months. If you have any questions or comments please give us a call at 1-800-752-5582 M-F 8:00am -5:00pm MST.

Iowa Department of Public Health - Sales in Iowa require this to be completed, signed and returned. These signatures will be retained on file for two years.



First Name: _____ Last Name: _____

Address: _____ City: _____

State: _____ Zip Code: _____

Country: USA CANADA MEXICO OTHER _____

Phone # _____ - _____ - _____ Email Address: _____

Date of Purchase: _____ Date of Install: _____

Installed By: SELF Plumbing Professional Where Purchased: _____

Model Number: _____ Serial Number: _____ - _____
 XXXXX - XXXXXX

Watts Premier, Inc.
Phone: 800-752-5582

1725 W. Williams Drive C-20
www.wattspremier.com

Phoenix, AZ 85027
Fax: 623-931-0191

Service Record

Model Number: _____ Serial Number: _____

Date of Purchase: _____ Date of Install: _____ Installed by: _____

Date	Sediment Filter (6 months)	Carbon Pre-Filter (6 months)	Membrane (2-5 years)	Carbon Post-Filter (12months)	

NOTES:

Limited Warranty



What your Warranty Covers:

If any part of your WATTS PREMIER Reverse Osmosis System is defective in workmanship (excluding replaceable filters and membranes), return unit after obtaining a return authorization (see below), less tank, within 3 years of original retail purchase, WATTS PREMIER will repair or, at WATTS PREMIER'S option, replace the system at no charge.

How to obtain Warranty Service:

For warranty service, call 1-800-752-5582 for documentation and a return authorization number. Once the return authorization number has been created, ship your Reverse Osmosis unit (less tank) to our factory, freight and insurance prepaid, with proof of date of original purchase. Include a note stating the problem experienced and include your name, address and your return authorization number. No returns will be accepted with out the proper return authorization number. Premier will repair it, or replace it, and ship it back to you prepaid.

What this warranty does not cover:

This warranty does not cover defects resulting from improper installation, (contrary to WATTS PREMIER's printed instructions), from abuse, misuse, misapplication, improper maintenance, neglect, alteration, accidents, casualties, fire, flood, freezing, environmental factors, water pressure spikes or other such acts of God.

This warranty will be void if defects occur due to failure to observe the following conditions:

1. The Reverse Osmosis System must be hooked up to a potable municipal or well cold water supply.
2. The hardness of the water should not exceed 10 grains per gallon, or 170 ppm.
3. Maximum incoming iron must be less than 0.2 ppm.
4. The pH of the water must not be lower than 2 or higher than 11.
5. The incoming water pressure must be between 40 and 85 pounds per square inch.
6. Incoming water to the RO cannot exceed 105 degrees F (40 degrees C.)
7. Incoming TDS/Total Dissolved Solids not to exceed 1800 ppm.
8. Do not use with water that is micro biologically unsafe or of unknown quality without adequate disinfection before or after the system.

This warranty does not cover any equipment that is relocated from the site of its original installation.

This warranty does not cover any charges incurred due to professional installation.

This warranty does not cover any equipment that is installed or used outside the United States of America and Canada.

LIMITATIONS AND EXCLUSIONS:

WATTS PREMIER WILL NOT BE RESPONSIBLE FOR ANY IMPLIED WARRANTIES, INCLUDING THOSE OF MERCHANTABILITY AND FITNESS FOR A PARTICULAR PURPOSE. PREMIER WILL NOT BE RESPONSIBLE FOR ANY INCIDENTAL OR CONSEQUENTIAL DAMAGES, INCLUDING TRAVEL EXPENSE, TELEPHONE CHARGES, LOSS OF REVENUE, LOSS OF TIME, INCONVENIENCE, LOSS OF USE OF THE EQUIPMENT, AND DAMAGE CAUSED BY THIS EQUIPMENT AND ITS FAILURE TO FUNCTION PROPERLY. THIS WARRANTY SETS FORTH ALL OF PREMIER'S RESPONSIBILITIES REGARDING THIS EQUIPMENT.

OTHER CONDITIONS:

If PREMIER chooses to replace the equipment, WATTS PREMIER may replace it with reconditioned equipment. Parts used in repairing or replacing the equipment will be warranted for 90 days from the date the equipment is returned to you or for the remainder of the original warranty period, whichever is longer. This warranty is not assignable or transferable.

YOUR RIGHTS UNDER STATE LAW:

Some states do not allow limitations on how long an implied warranty lasts, and some states do not allow the exclusion or limitation of incidental or consequential damages, so the above limitations or exclusions may not apply. This warranty gives you specific legal rights, and you may have other legal rights which vary from state to state.